

MM-13

1080p 60fps HD-SDI Board camera



FEATURES

- 1/2.8" Sony Exmor CMOS sensor
2.18Mpixels(Total) / 2.12Mpixels(Active)
- Full HD Resolution
1920x1080p / 30fps(25fps) 1920x1080i / 60fps(50fps)
1280x720p/60fps(50fps) 1280x720p / 60fps(50fps)
1920x1080p / 60fps(50fps)
- DAY & NIGHT
This camera supports filter changed day and night function using DC Motor controller. It can be changeable OLPF day to night depending on the luminance level using DC Motor. It can be also controlled by external Day and Night port.
- WDR (Wide Dynamic Range)
WDR, more effectively than previous models, by applying an optimum fusion ratio when combining the high speed shutter used in bright areas and the low speed shutter used in dark areas.
- DNR (Digital Noise Reduction, 2D+3D)
The DNR technology eliminates noise thus generating a distinct and clear image. This camera DNR function utilizes both an adaptive 2D filter reducing noise in the brightness of the image and an adaptive 3D filter reducing noise caused by movement.
- Privacy mask Function
The privacy zone function makes it possible to make specific areas of the scene from view.
- On Screen Display
This camera supports the OSD function. And so, the camera can be controlled by selecting text displayed on the monitor screen.
- Intelligent motion detection
You can transmits an alert signal when it detects motion of an object on the screen. This feature is useful when you have to monitor several screens simultaneously.
- Output
Digital output : HD-SDI Analog output : NTSC, PAL Composite (without WDR)
- Protocol This camera supports the multi-protocol (VISCA, PELCO-D, PELCO-P)

DIMENSIONS

Unit : mm

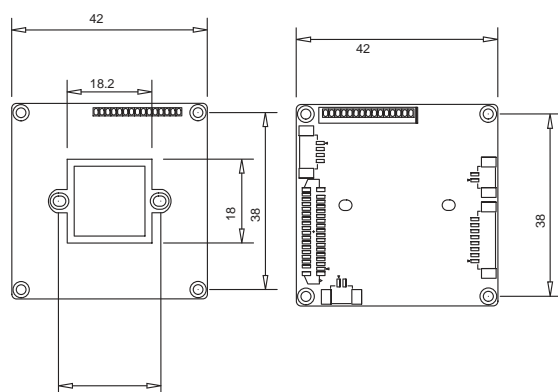

SPECIFICATIONS

MM-13	
Image Sensor	1/2.8" Sony Exmor CMOS
Total Pixels	1952(H) x 1116(V) = 2.18M pixels
Active pixels	1936(H) x 1096(V) = 2.12M pixels
Scanning system	Progressive
Resolution	Digital : 1920x1080p(1080p/30fps) , 1280x720p(720p/60fps) 1920x1080i(1080i/60fps) , 1920x1080p(1080p/60fps) Analog : 700TVL
Min. illumination	Color : 1.0 lux , BW : 0.5lux Color DSS : 0.002 lux , BW DSS : 0.001 lux
Video Output	HD : HD-SDI Analog : NTSC / PAL (without WDR)
S/N Ratio	more than 50dB (AGC off)
MODEL	D&N / COLOR / IR CDS
LENS	DC / Manual
Brightness	0 ~ 20
Shutter speed	Auto / Manual (x2, x3, x4, 1/30(1/25) ~ 1/60000)
DSS	Off / x2 / x3 / x4
AGC	Off / On
Flickerless	Off / On
WDR/BLC	Off / WDR / BLC
DAY&NIGHT	Auto / Ext-in / Day / Night
WHITE BAL	Auto / One Push / Manual / Indoor / Outdoor
HLC	Off / On / Night
DNR	Off / Low / Middle / High / Auto
Mirror	Off / H / V / H&V
Sharpness	0 ~ 10
ACE	Off / Low / Middle / High
Defog	Off / On (Auto / Manual)
Freeze	Off / On
GAMMA	0.45 / 0.50 / 0.55 / 0.60 / 0.65
E.Zoom	Off / Max x2 ~ x32
PRIVACY	Off / On (Box 24 points , Polygon 8 points)
MOTION	Off / On (3 points)
Defect	One Push
System	NTSC / PAL
HD Format	1080P_30fps / 1080I_60fps / 720P_60fps / 1080P_60fps
Comm	Baud Rate : 2400 / 4800 / 9600 / 19200 / 38400 / 57600 / 115200 Protocol : VISCA / Pelco-D / Pelco-P / Update
Disp Sel (Off / On)	ID / Title / Zoom Ratio / System Message
Set Title	Text Edit
Init Sel (Off / On)	ID / Baud Rate / Protocol / Version / Init. Message
Set Init Msg	Text Edit
Language	English / Simplified Chinese / Traditional Chinese / Japanese
Power Source	DC12V±10%
Power Consumption	250mA
Power Input	Connector
Video Output(HD-SDI)	MMCX Connector
Operating Temperature	-10℃ ~ +50℃ (Humidity : 0%RH ~ 80%RH)
Storage Temperature	-20℃ ~ +60℃ (Humidity : 0%RH ~ 90%RH)
Dimension (H x V x T)	42mm X 42mm X 1.6mm

CONFIDENTIAL

2.1Mpixels Module
MM-13

Edition : v1.01

Issued Date: 29. Oct. 13

CUSTOMER'S APPROVAL SHEET

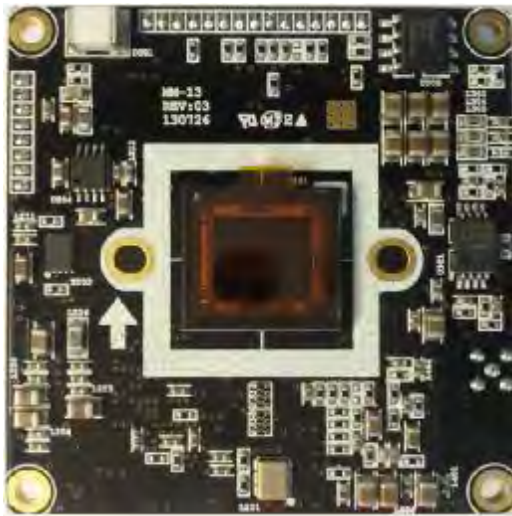



Contents

1. Feature
2. Cautions
3. Specification
4. Connector
5. Block Diagram
6. Protocol
7. Command List
8. OSD Menu
9. Drawing

**Feature**

- **1/2.8" Sony Exmor CMOS sensor**
2.18Mpixels(Total) / 2.12Mpixels(Active)
- **Full HD Resolution**
1920x1080p / 30fps(25fps)
1920x1080i / 60fps(50fps)
1280x720p / 60fps(50fps)
1920x1080p / 60fps(50fps)
- **DAY & NIGHT**
This camera supports filter changed day and night function using DC Motor controller. It can be changeable OLPF day to night depending on the luminance level using DC Motor. It can be also controlled by external Day and Night port.
- **WDR (Wide Dynamic Range)**
WDR, more effectively than previous models,
by applying an optimum fusion ratio when combining the high speed shutter used in bright areas and the low speed shutter used in dark areas.
- **DNR (Digital Noise Reduction, 2D+3D)**
The DNR technology eliminates noise thus generating a distinct and clear image. This camera DNR function utilizes both an adaptive 2D filter reducing noise in the brightness of the image and an adaptive 3D filter reducing noise caused by movement.
- **Privacy mask Function**
The privacy zone function makes it possible to make specific areas of the scene from view.
- **On Screen Display**
This camera supports the OSD function. And so, the camera can be controlled by selecting text displayed on the monitor screen.
- **Intelligent motion detection**
You can transmits an alert signal when it detects motion of an object on the screen. This feature is useful when you have to monitor several screens simultaneously.

- **Output**

Digital output : HD-SDI

Analog output : NTSC, PAL Composite (without WDR)

- **Protocol**

This camera supports the multi-protocol (VISCA, PELCO-D, PELCO-P)

**Cautions****• Power Supply**

This camera must always be operated a DC 12V

• Handling of the unit

Be careful not to spill water or other liquids on the unit.

• Operating and storage location

Avoid viewing a very bright object (such as light fittings) during an extended period. Avoid operating or storing the unit in the following locations.

Extremely hot or cold places (operating temperature $-10\text{ }^{\circ}\text{C} \sim 50\text{ }^{\circ}\text{C}$, however, we recommend that the unit be used within a temperature range of $0\text{ }^{\circ}\text{C} \sim 45\text{ }^{\circ}\text{C}$)

Damp or dust place

Places exposed to rain

Places subject to strong vibration

Close to generators of powerful electromagnetic radiation such as radio or TV transmitters.

• Handing of the Unit

Remove dust or dirt on the surface of the CMOS sensor with a blower.

Avoid the use of volatile solvents such as thinners, alcohol, benzene and insecticides. They may damage the surface finish and/or impair the operation of the camera.

CONFIDENTIAL

2.1Mpixels Module MM-13

Edition : v1.01

Issued Date: 29. Oct. 13

Specification

Model	MM- 13
Image Sensor	1/2.8" Sony Exmor CMOS
Total Pixels	1952(H) x 1116(V) = 2.18M pixels
Active pixels	1936(H) x 1096(V) = 2.12M pixels
Scanning system	Progressive
Resolution	Digital ; 1920x1080p(1080p/30fps) , 1280x720p(720p/60fps) 1920x1080i(1080i/60fps) , 1920x1080p(1080p/60fps) Analog : 700TVL
Min. illumination	Color : 1.0 lux , BW : 0.5lux Color DSS : 0.002 lux , BW DSS : 0.001 lux
Video Output	HD : HD- SDI Analog : NTSC / PAL (without WDR)
S/N Ratio	more than 50dB (AGC off)
Function	
MODEL	D&N / COLOR / IR CDS
EXPOSURE	
LENS	DC / Manual
Brightness	0 ~ 20
Shutter speed	Auto / Manual (x2, x3, x4, 1/30(1/25) ~ 1/60000)
DSS	Off / x2 / x3 / x4
AGC	Off / On
Flickerless	Off / On
WDR/BLC	Off / WDR / BLC
DAY&NIGHT	Auto / Ext- in / Day / Night
WHITE BAL	Auto / One Push / Manual / Indoor / Outdoor
IMAGE	
HLC	Off / On / Night
DNR	Off / Low / Middle / High / Auto
Mirror	Off / H / V / H&V
Sharpness	0 ~ 10
ACE	Off / Low / Middle / High
Defog	Off / On (Auto / Manual)
Freeze	Off / On
GAMMA	0.45 / 0.50 / 0.55 / 0.60 / 0.65
E.Zoom	Off / Max x2 ~ x32
INTELLIGENCE	
PRIVACY	Off / On (Box 24 points , Polygon 8 points)
MOTION	Off / On (3 points)

CONFIDENTIAL

2.1Mpixels Module MM-13

Edition : v1.01

Issued Date: 29. Oct. 13

Specification

Model	MM-13
Special Func	
Defect	One Push
System	NTSC / PAL
HD Format	1080P_30fps / 1080I_60fps / 720P_60fps / 1080P_60fps
Comm	Baud Rate : 2400 / 4800 / 9600 / 19200 / 38400 / 57600 / 115200 Protocol : VISCA / Pelco- D / Pelco- P / Update
Display	
Disp Sel (Off / On)	ID / Title / Zoom Ratio / System Message
Set Title	Text Edit
Init Sel (Off / On)	ID / Baud Rate / Protocol / Version / Init. Message
Set Init Msg	Text Edit
Language	English / Simplified Chinese / Traditional Chinese / Japanese
Electrical	
Power Source	DC12V±10%
Power Consumption	250mA
General	
Power Input	Connector
Video Output(HD- SDI)	MMCX Connector
Operating Temperature	- 10℃ ~ +50℃ (Humidity : 0%RH ~ 80%RH)
Storage Temperature	- 20℃ ~ +60℃ (Humidity : 0%RH ~ 90%RH)
Dimension (H x V x T)	42mm X 42mm X 1.6mm

Connector

Top View



Bottom View



1. J201 : I/O Connector-1

Pin NO	Pin Name	Description	Normal	Active	I/O
1	DC+12V	DC+12V Input			I
2	GND	Board Ground			-
3	VBS	Composite Video Output(Main)			O
4	NC	NC			-
5	GND	Board Ground			-
6	NC	NC			-
7	ADKEY	OSD Control			I
8	GND	Board Ground			-
9	IR-ON	IR Lamp Control			O
10	D/N-IN	Day & Night Control Input	+3.3V	0V	I
11	GPIO	Optional			I/O
12	MD-OUT	Motion Detection output			O
13	GND	Board Ground			-
14	485(+)	RS-485 Data+			I/O
15	485(-)	RS-485 Data-			I/O

Yeonho Electronics, 12512WS-15

2. J401 : HD -SDI Connector

Pin NO	Pin Name	Description	Normal	Active	I/O
1	SDO	HD-SDI Output			O
2	GND	Board Ground			-
RF Connector - MMCX					

3. J202 : Connector for upgrading Camera Program

Pin NO	Pin Name	Description	Normal	Active	I/O
1	JMODE	JTAG Upgrade Mode Setting	+3.3V	0V	I
2	JTCK	JTAG Upgrade Clock			I
3	JTDI	JTAG Upgrade Data Input			I
4	JTDO	JTAG Upgrade Data Output			O
5	JTMS	JTAG Upgrade Chip Selector			I
6	GND	Board Ground			-
7	RXD	UART (Rxd)			I
8	TXD	UART (Txd)			O
Yeonho Electronics, 12505WS-08					

4. J302 : Day & Night Motor Control Connector

Pin NO	Pin Name	Description	Normal	Active	I/O
1	CONT(+)	Day & Night Motor Drive + Output	Open	4.5/0V	O
2	CONT(-)	Day & Night Motor Drive - Output	Open	0/4.5V	O
Yeonho Electronics, 12505WS-02					

5. J301 : Auto Iris Lens Control Connector

Pin NO	Pin Name	Description	Normal	Active	I/O
1	DMP+	DC Iris Damping Motor +	DAMP+		O
2	DMP-	DC Iris Damping Motor -	DAMP-		O
3	DRV+	DC Iris Motor Drive	DRIVE+		O
4	GND	Board Ground	DRIVE-		-
Yeonho Electronics, 12505WS-04					

Connector

1. D&N IN (J201-10)

Port giving input of any external signal in Day&Night “Ext-In” Mode

- Day Mode : High (+3.3V)
- Night Mode : Low (Ground)

2. AD KEY (J201-8)

The external wired remote controller connector.

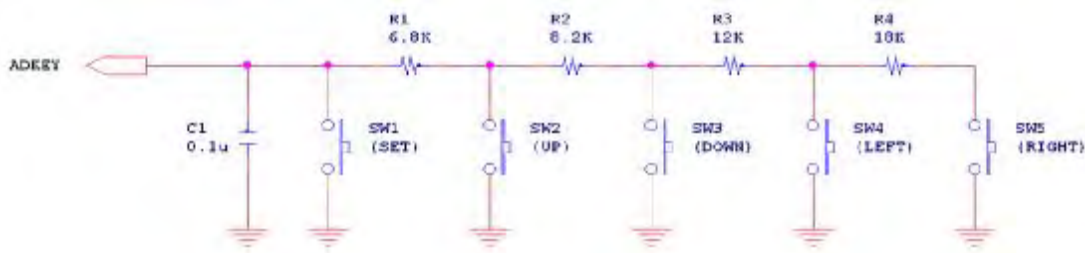

3. MD (J201-12)

Port giving signal output of Motion Detection Alarm

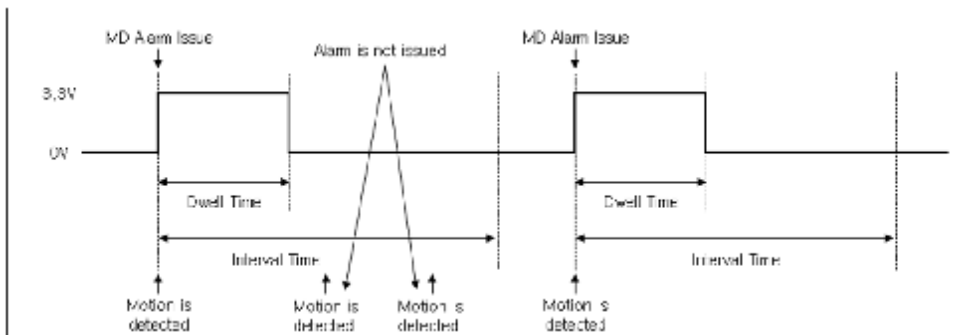

Block Diagram

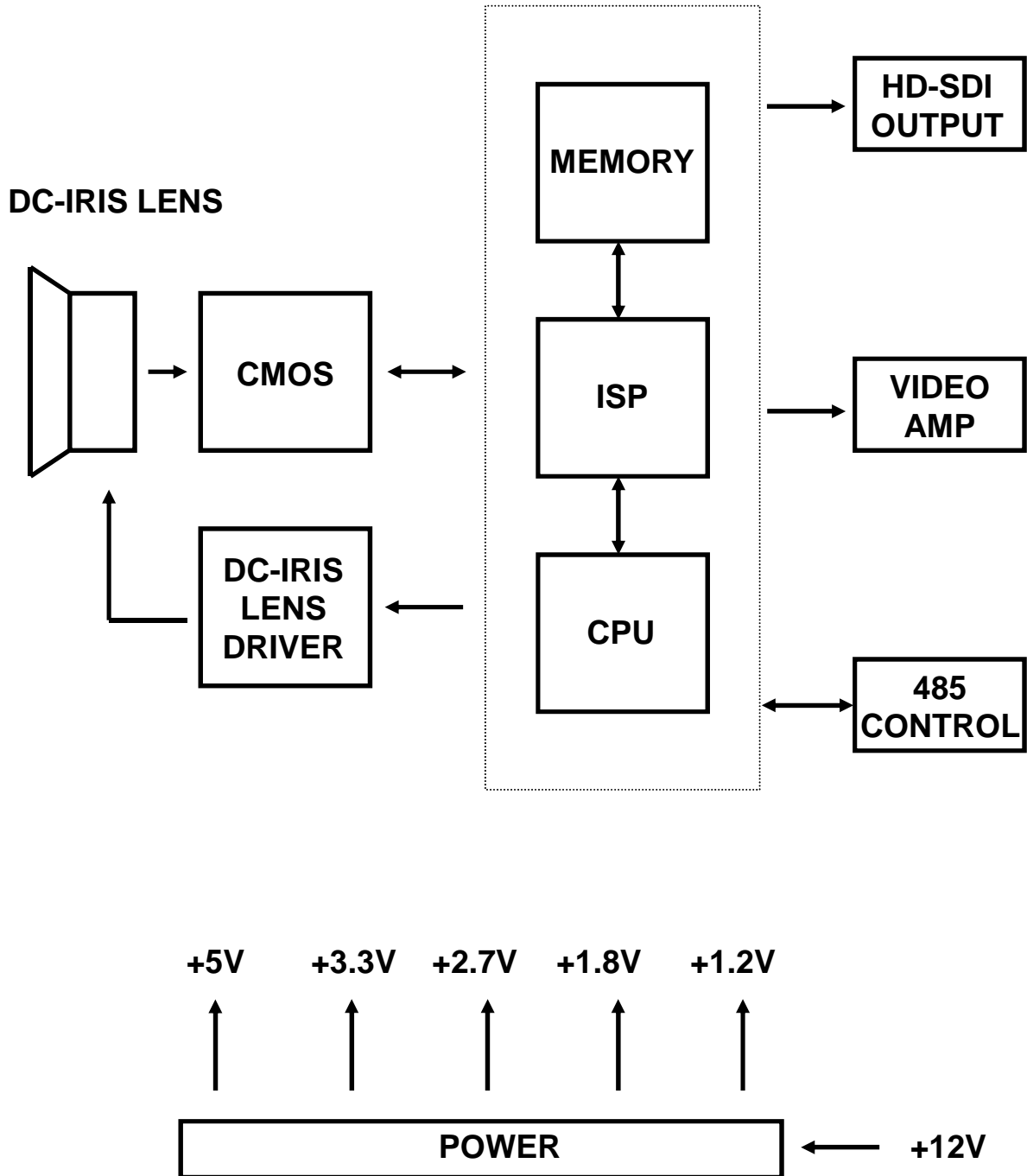

Protocol
1. Timing

As Command processing can only be carried out one time in a Vertical cycle, it takes the maximum 1V cycle time for an ACK/Completion to be returned. If the Command ACK/Completion communication time can be cut shorter than the 1V cycle time, then every 1V cycle can receive a Command.(NTSC:33.3ms, PAL:40ms)

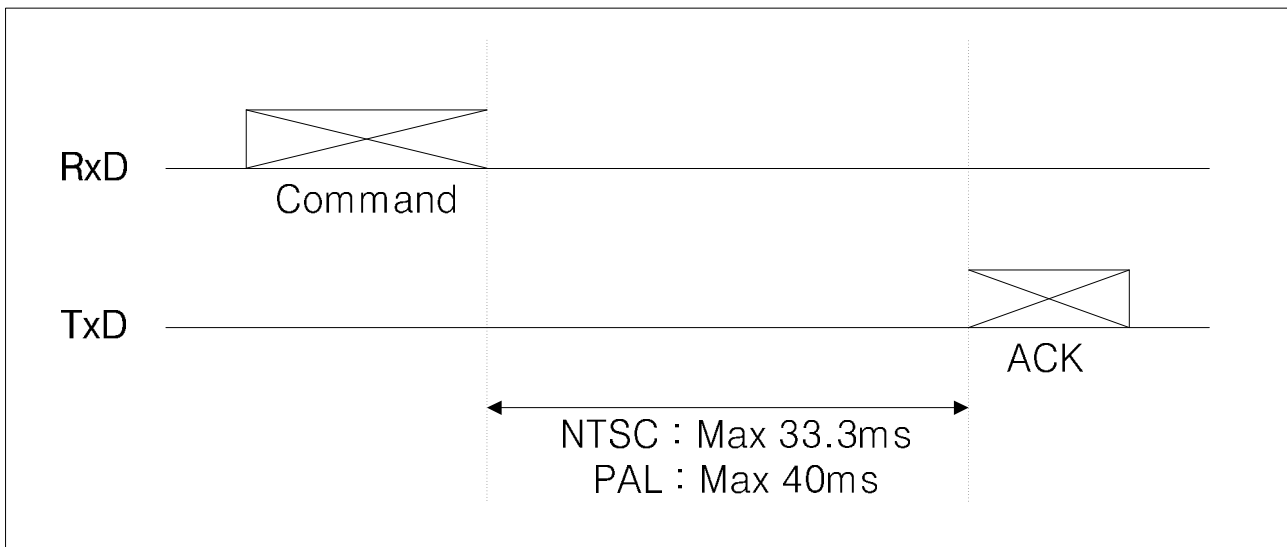
**2. Communication parameter**

- Protocol : VISCA, Pelco-D, Pelco-P
- ID : 1~7 (VISCA), 1~255(Pelco-D, Pelco-P)
- Baud rate : 2400, 4800, 9600, 19200, 38400, 57600, 115200 bps
- Data bit : 8
- Start bit : 1
- Stop bit : 1
- Non parity bit

Protocol
3. Pelco-D Protocol Command List

Function	Message format (Hex)						
	Byte1	Byte2	Byte3	Byte4	Byte5	Byte6	Byte7
Zoom Tele	FF	ID	00	20	00	00	CS
Zoom Wide	FF	ID	00	40	00	00	CS
Focus Near	FF	ID	01	00	00	00	CS
Focus Far	FF	ID	00	80	00	00	CS
Stop	FF	ID	00	00	Don't care		CS
Menu (Set)	FF	ID	00	03 or 07	00	5F	CS
Esc	FF	ID	00	03 or 07	00	60	CS
Up	FF	ID	00	08	00	XX	CS
Down	FF	ID	00	10	00	XX	CS
Left	FF	ID	00	04	XX	00	CS
Right	FF	ID	00	02	XX	00	CS
Set Zoom Preset	FF	ID	00	03	00	Preset ID (01 ~ 05)	CS
Clear Zoom Preset	FF	ID	00	05	00	Preset ID (01 ~ 05)	CS
Go to Zoom Preset	FF	ID	00	07	00	Preset ID (01 ~ 05)	CS
Focus Mode	FF	ID	00	2B	00	00,01:Auto 02 : Manual	CS

- ID : Camera ID (1 ~ 255)
- XX : Speed (10h < XX ≤ 40h)
- CS(Check Sum) : An 8bit sum of byte 2 ~ 6 in the message.

Protocol

4. Pelco-P Protocol Command List

Function	Message format (Hex)							
	Byte1	Byte2	Byte3	Byte4	Byte5	Byte6	Byte7	Byte8
Zoom Tele	A0	ID	00	20	00	00	AF	CS
Zoom Wide	A0	ID	00	40	00	00	AF	CS
Focus Near	A0	ID	02	00	00	00	AF	CS
Focus Far	A0	ID	01	00	00	00	AF	CS
Stop	A0	ID	00	00	Don't care		AF	CS
Menu (Set)	A0	ID	00	03 or 07	00	5F	AF	CS
Esc	A0	ID	00	03 or 07	00	60	AF	CS
Up	A0	ID	00	08	00	XX	AF	CS
Down	A0	ID	00	10	00	XX	AF	CS
Left	A0	ID	00	04	XX	00	AF	CS
Right	A0	ID	00	02	XX	00	AF	CS
Set Zoom Preset	A0	ID	00	03	00	Preset ID (01 ~ 05)	AF	CS
Clear Zoom Preset	A0	ID	00	05	00	Preset ID (01 ~ 05)	AF	CS
Go to Zoom Preset	A0	ID	00	07	00	Preset ID (01 ~ 05)	AF	CS

- ID : Camera ID (1 ~ 255)
- XX : Speed (10h < XX ≤ 40h)
- CS(Check Sum) : An XOR sum of byte 1 ~ 7 in the message.

Protocol

5. Visca Protocol

● **Command packet (Variable packet length)**

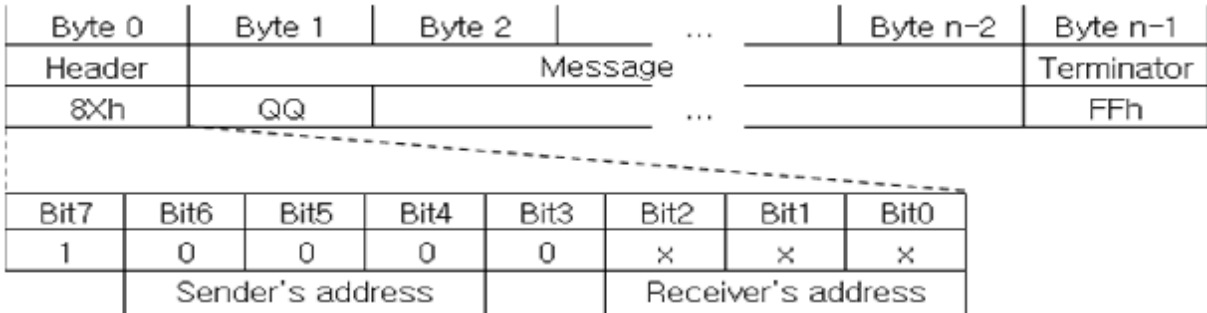

- X : 1 ~ 7 (Camera address)
- QQ : 01 (Command), 09 (Inquiry)

● **Ack message packet (Variable packet length)**

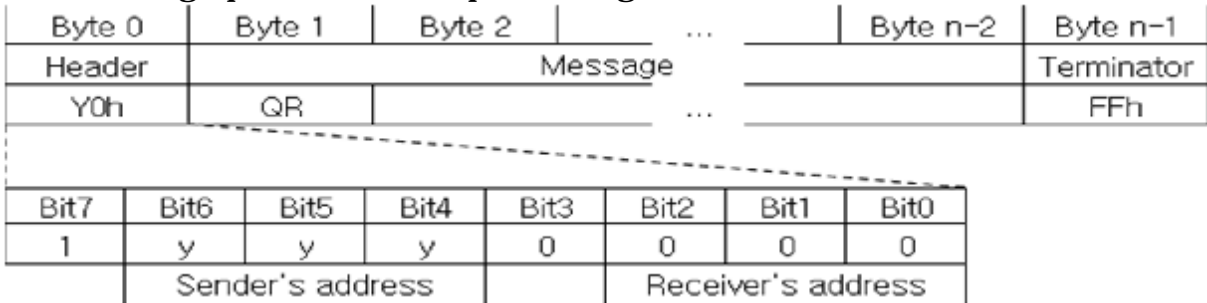

- Y : 9 ~ F (Camera address + 8)
- Q : 4 (Receive Ack), 5 (Completion message), 6 (Error message)
- R : Socket Number (1 ~ 3)

※ When command messages are sent to the camera, it is normal to send the next command message after waiting for the completion message or error message to return. However to deal with advanced uses, the camera has three buffers (memories) for commands, so that up to three commands including the commands currently being executed can be received. When the camera receives commands, it notifies the sender which command buffer was used using the socket number of the ACK message.

Ack type	Reply packet	SS	Description
Receive Ack	Y0 4R FF	01	Message length error
Completion (Commands)	Y0 5R FF	02	Syntax error
Completion (Inquiries)	Y0 50 ... FF	03	Command buffer full
Error	Y0 6R SS FF	04	Command cancelled
		05	No socket (to be cancelled)
		41	Command not executable

Protocol

● **Example of communication**

- Camera ID : 1
- Socket number : 1

※ **Command**

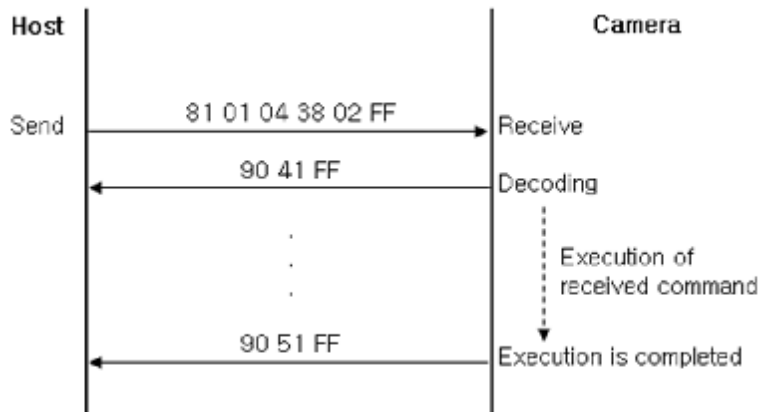

※ **Inquiry command**

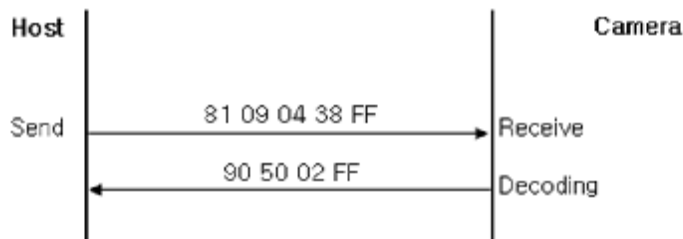

● **Network change message**

- Sent from the peripheral device to the controller when a device is removed from or added to the network. The address must be re- set when this message is received.

Y0 38 FF

- Y : 9 ~ F (Camera address + 8)

Command List

< Command >

Command Set	Command	Command Packet	Comments
AddressSet	Broadcast	88 30 01 FF	Address setting
IF_Clear	Broadcast	88 01 00 01 FF	I/F Clear
		8x 01 00 01 FF	
CommandCancel		8x 2p FF	p : Socket No.(1 ~ 3)
CAM_Power	Power Reset	8x 01 04 00 03 FF	Camera Rebooting
CAM_Dzoom	On	8x 01 04 06 02 FF	Digital Zoom ON/OFF
	Off	8x 01 04 06 03 FF	
	Stop	8x 01 04 06 00 FF	
	Tele (Variable)	8x 01 04 06 2p FF	p : 0(Slow) ~ 7(Fast)
	Wide (Variable)	8x 01 04 06 3p FF	
	x1/Max	8x 01 04 06 10 FF	x1/Max Magnification switchover
	Direct	8x 01 04 46 00 00 0p 0q FF	pq : D-Zoom Position
CAM_Initialize	Comp Scan	8x 01 04 19 02 FF	Execute White spot compensation
	Comp Scan Thrs	8x 01 04 19 03 00 0p 0q FF	pq : Threshold of White spot compensation
CAM_WB	Auto	8x 01 04 35 00 FF	Normal Auto
	Indoor	8x 01 04 35 01 FF	Indoor Mode
	Outdoor	8x 01 04 35 02 FF	Outdoor Mode
	One Push AWB	8x 01 04 35 03 FF	One Push AWB Mode
	Manual	8x 01 04 35 05 FF	Manual Control Mode
	One Push Trigger	8x 01 04 10 05 FF	One Push AWB trigger
CAM_Rgain	Reset	8x 01 04 03 00 FF	R Gain Manual setting
	Up	8x 01 04 03 02 FF	
	Down	8x 01 04 03 03 FF	
	Direct	8x 01 04 43 00 00 0p 0q FF	
CAM_Bgain	Reset	8x 01 04 04 00 FF	B Gain Manual setting
	Up	8x 01 04 04 02 FF	
	Down	8x 01 04 04 03 FF	
	Direct	8x 01 04 44 00 00 0p 0q FF	
CAM_Chroma	Direct	8x 01 04 13 00 00 0p 0q FF	pq : Chroma level (0~14h)
CAM_LENS	Type	8x 01 04 49 00 00 FF	Manual Lens
		8x 01 04 49 00 01 FF	DC Iris Lens
	Mode	8x 01 04 49 01 0p 0q FF	p : Manual Lens Mode (0:Normal, 1:Deblur) q : DC Iris Lens Mode (0:Indoor, 1:Outdoor, 2:Deblur)
CAM_ShutterMode	Auto	8x 01 04 39 00 FF	Auto exposure mode
	Manual	8x 01 04 39 03 FF	Manual control mode
CAM_Shutter	Reset	8x 01 04 0A 00 FF	Shutter setting
	Up	8x 01 04 0A 02 FF	
	Down	8x 01 04 0A 03 FF	
	Direct	8x 01 04 4A 00 00 0p 0q FF	
CAM_AGC	On	8x 01 04 5C 02 FF	AGC Mode
	Off	8x 01 04 5C 03 FF	

Command List

< Command >

Command Set	Command	Command Packet	Comments
CAM_SlowShutter	Auto (On)	8x 01 04 5A 02 FF	Auto Slow Shutter ON/OFF
	Manual (Off)	8x 01 04 5A 03 FF	
CAM_MaxDSSLev	Direct	8x 01 04 5A 1p FF	P :Max Slowshutter level (0:x2, 1:x3, 2:x4)
CAM_ExpComp	On	8x 01 04 3E 02 FF	Exposure Compensation ON/OFF
	Off	8x 01 04 3E 03 FF	
	Reset	8x 01 04 0E 00 FF	Exposure Compensation amount setting
	Up	8x 01 04 0E 02 FF	
	Down	8x 01 04 0E 03 FF	
	Direct	8x 01 04 4E 00 00 0p 0q FF	
CAM_Flickerless	On	8x 01 04 7A 02 FF	Flickerless ON/OFF
	Off	8x 01 04 7A 03 FF	
CAM_BLC	On	8x 01 04 33 02 FF	Back Light Compensation
	Off	8x 01 04 33 03 FF	
CAM_BLCFunc	Area OSD Display	8x 01 04 3C 0p FF	p : 0(Area OSD Off), 1(Area OSD On)
	Area Start X	8x 01 04 3C 10 00 0p 0q FF	pq : Start Horizontal Position (0 ~ 36h)
	Area Start Y	8x 01 04 3C 20 00 0p 0q FF	pq : Start Vertical Position (0 ~ 3Ch)
	Area End X	8x 01 04 3C 30 00 0p 0q FF	pq : End Horizontal Position (4~3Ah)
	Area End Y	8x 01 04 3C 40 00 0p 0q FF	pq : End Vertical Position (4~40h)
CAM_HLC	Mode	8x 01 04 32 0p FF	p : HLC Mode - 0(Off), 1(On), 2(Night)
	Level	8x 01 04 32 10 00 0p 0q FF	pq : HLC Level (0~14h)
	Clip Color	8x 01 04 32 3p FF	p : HLC Color - 0 ~ Dh (0:BLK, 1~6:Gray1~6, 7:WHT, 8:RED, 9:GRN, Ah:BLU, Bh:CYN, Ch:YEL, Dh:MAG)
CAM_WD	On	8x 01 04 3D 02 FF	Wide-D ON/OFF
	Off	8x 01 04 3D 03 FF	
CAM_WD_Level	Direct	8x 01 04 7D 0p FF	p : WDR Level (0 ~ 4)
CAM_ACE	On	8x 01 04 1A 02 FF	ACE ON/OFF
	Off	8x 01 04 1A 03 FF	
CAM_ACELevel	Direct	8x 01 04 1A 10 0p FF	p : ACE Level (0 ~ 2)
CAM_Defog	On	8x 01 04 65 02 FF	Defog ON/OFF
	Off	8x 01 04 65 03 FF	
	Level	8x 01 04 65 10 0p FF	p : Defog Level(0 ~ 2)
	Mode	8x 01 04 65 20 0p FF	p : 0(Manual), 1(Auto)
CAM_DNR	Mode	8x 01 04 53 0p FF	p : 0 (Off), 1 ~ 3 (Manual Level), 4 (Auto)
CAM_GAMMA	Direct	8x 01 04 5B 0p FF	p: Gamma setting - 0(0.45) ~ 4(0.65)
CAM_Aperture	Reset	8x 01 04 02 00 FF	Aperture Control
	Up	8x 01 04 02 02 FF	
	Down	8x 01 04 02 03 FF	
	Direct	8x 01 04 42 00 00 0p 0q FF	pq : Aperture Gain (0~Ah)
CAM_LR_Reverse	On	8x 01 04 61 02 FF	Mirror Image ON/OFF
	Off	8x 01 04 61 03 FF	
CAM_Freeze	On	8x 01 04 62 02 FF	Freeze Picture ON/OFF
	Off	8x 01 04 62 03 FF	

Command List

< Command >

Command Set	Command	Command Packet	Comments
CAM_PictureFlip	On	8x 01 04 66 02 FF	Picture Reverse On/Off (Up side down)
	Off	8x 01 04 66 03 FF	
CAM_ICR	Night	8x 01 04 01 02 FF	ICR Mode ON/OFF
	Day	8x 01 04 01 03 FF	
	Auto	8x 01 04 51 02 FF	ICR is changed automatically by AGC Gain
	Ext-In	8x 01 04 51 05 FF	ICR is changed by external input
	Threshold	8x 01 04 21 00 00 0p 0q FF	pq : Trheshold level of Auto mode (0 ~ 1Ch)
	Gap	8x 01 04 21 10 00 00 0p FF	pq : On/Off Threshold Gap of Auto mode (0 ~ 4)
	Auto ICR Delay	8x 01 04 41 00 00 0p 0q FF	pq : Auto mode delay - 0(0sec) ~ FFh(255sec)
	Ext-In Delay	8x 01 04 71 00 00 0p 0q FF	pq : Ext-In mode delay - 0(0sec) ~ FFh(255sec)
	Burst On	8x 01 04 72 02 FF	Burst On/Off
	Burst Off	8x 01 04 72 03 FF	
CAM_MEMORY	Reset	8x 01 04 3F 00 0p FF	p : Memory number (0 ~ 8)
	Set	8x 01 04 3F 01 0p FF	
	Recall	8x 01 04 3F 02 0p FF	
CAM_CUSTOM	Reset	8x 01 04 3F 00 7F FF	Starts in this mode at Power On
	Set	8x 01 04 3F 01 7F FF	
	Recall	8x 01 04 3F 02 7F FF	
CAM_MemSave	Write	8x 01 04 23 0t 0p 0q 0r 0s FF	t : 00 ~ 07 (Address) Total 16Byte pqrs : 0000 ~ FFFFh (Data)
CAM_Display	On	8x 01 04 15 02 FF	Display ON/OFF
	Off	8x 01 04 15 03 FF	
	On/Off	8x 01 04 15 10 FF	
CAM_MultiLineTitle	Title Set1	8x 01 04 73 1L 00 nn 00 00 00 00 00 00 00 00 FF	L : Line Number (0 ~ Dh) nn : H-Position (0 ~ 27h)
	Title Set2	8x 01 04 73 2L mm nn pp qq rr ss tt uu vv ww FF	L : Line Number (0 ~ Dh) mnpqrstuvw : Set of characters (1 ~ 10)
	Title Set3	8x 01 04 73 3L mm nn pp qq rr ss tt uu vv ww FF	L : Line Number (0 ~ Dh) mnpqrstuvw : Set of characters (11~ 20)
	Title Clear	8x 01 04 74 1p FF	Title Set clear (p: 0 ~ Dh, Fh= all line)
	On	8x 01 04 74 2p FF	Title display On/Off (0 ~ Dh, Fh= all line)
	Off	8x 01 04 74 3p FF	
CAM_MENUKey	Up	8x 01 04 16 01 FF	
	Down	8x 01 04 16 02 FF	
	Left	8x 01 04 16 04 FF	
	Right	8x 01 04 16 08 FF	
	Menu	8x 01 04 16 10 FF	
	ESC	8x 01 04 16 20 FF	

Command List

< Command >

Command Set	Command	Command Packet	Comments
CAM_DispSel		8x 01 04 14 00 0p FF	Display Item On(1)/Off(0) p : bit[0] - ID, bit[1] - Title, bit[2] - Zoom Position, bit[3] - System Message
CAM_Use OSD	Display String	8x 01 05 10 xx yy cc ss "nnnnnnnnnnnn" FF	xx : X position (0 ~ 27h) yy : Y Position (0 ~ Dh) cc : Color (Fixed, 07 : White) ss : NORMAL = 00 INVERSE = 01 BLINK = 02 "nnnnn...." : Display String (Max 26 char)
	Blue Screen	8x 01 05 20 0p FF	p : Blue Screen Display - 0(Off), 1(On)
	Screen Clear	8x 01 05 30 01 FF	Screen All clear
CAM_Mute	On	8x 01 04 75 02 FF	Mute On/Off
	Off	8x 01 04 75 03 FF	
	On/Off	8x 01 04 75 10 FF	
CAM_PrivacyZone	Display String	8x 01 04 77 pp pp pp pp FF	Mask Display On/Off pppppppp : Mask Settings (0: OFF, 1: ON)
	SetMaskColor	8x 01 04 78 pp pp pp pp qq rr FF	pppppppp : Mask Color Settings qq : Color Setting when 0 is selected rr : Color Setting when 1 is selected
	Non_InterlockMask	8x 01 04 6F mm 0p 0p 0q 0q 0r 0r 0s 0s FF	mm : Non-Interlock Mask Number pp : X, qq : Y, rr : W, ss : H
CAM_KeyLock	Off	8x 01 04 17 02 FF	Key Lock On/Off
	On	8x 01 04 17 03 FF	
CAM_IDWrite		8x 01 04 22 0p 0q 0r 0s FF	pqrs : Camera ID (0000 ~ FFFFh)
CAM_MD	On	8x 01 04 1B 02 FF	Motion Detection On/Off
	Off	8x 01 04 1B 03 FF	
	Function Set	8x 01 04 1C 0m 0n 0p 0q 0r 0s FF	m : Display mode n : Detection Frame Set (bit[0]:1, bit[1]:2, bit[3]:3) pq : Threshold Level (00 ~ 14h) rs : Interval Time set (00 ~ FFh)
	Window Set	8x 01 04 1D 0m 0p 0q 0r 0s FF	m : Select Detection Frame Number (0,1,2) p : Start Horizontal Position (00 ~ 0Eh) q : Start Vertical Position (00 ~ 07) r : End Horizontal Position (01 ~ 0Fh) s : End Vertical Position (01 ~ 08h)
	Alarm(Reply)	y0 07 04 1B 0p FF	p : Detection Frame Number
CAM_RegisterValue		8x 01 04 24 mm 0p 0q FF	mm : Register No. (00, 52h, 60h, 72h, 73h, 7Ah) pq : Register Value

Command List

< Inquiry Command >

Inquiry Command	Command Packet	Inquiry Packet	Comments
CAM_DZoomModelnq	8x 09 04 06 FF	y0 50 02 FF	D-Zoom On
		y0 50 03 FF	D-Zoom Off
CAM_DZoomPosInq	8x 09 04 46 FF	y0 50 00 00 0p 0q FF	pq : D-Zoom Position
CAM_CompScanThrsInq	8x 01 04 19 03 FF	y0 50 00 00 0p 0q FF	pq : White spot compensation Threshold (0~FFh)
CAM_WBModelnq	8x 09 04 35 FF	y0 50 00 FF	Auto
		y0 50 01 FF	Indoor
		y0 50 02 FF	Outdoor
		y0 50 03 FF	One Push AWB
		y0 50 05 FF	Manual
CAM_RGainInq	8x 09 04 43 FF	y0 50 00 00 0p 0q FF	pq : R Gain (0~14h)
CAM_BGainInq	8x 09 04 44 FF	y0 50 00 00 0p 0q FF	pq : B Gain (0~14h)
CAM_ChromaInq	8x 09 04 13 FF	y0 50 00 00 0p 0q FF	pq : Chroma level (0~14h)
CAM_LensTypeInq	8x 09 04 49 00 FF	y0 50 0p FF	p : 0(Manual), 1(DC)
CAM_LensModelnq	8x 09 04 49 01 FF	y0 50 00 00 0p 0q FF	p : Manual Lens Mode - 0(Normal), 1(Deblur) q : DC Lens Mode - 0(Indoor), 1(Outdoor), 2(Deblur)
CAM_ShutterModelnq	8x 09 04 39 FF	y0 50 00 FF	Auto
		y0 50 03 FF	Manual
CAM_ShutterPosInq	8x 09 04 4A FF	y0 50 00 00 0p 0q FF	pq : Shutter Position
CAM_SlowShutterModelnq	8x 09 04 5A FF	y0 50 02 FF	Auto
		y0 50 03 FF	Off
CAM_MaxDSSLevInq	8x 09 04 5A 10 FF	y0 50 0p FF	p :Max SlowShutter Level (0:x2, 1:x3, 2:x4)
CAM_AGCMModelnq	8x 09 04 5C FF	y0 50 02 FF	On
		y0 50 03 FF	Off
CAM_ExpCompModelnq	8x 09 04 3E FF	y0 50 02 FF	On
		y0 50 03 FF	Off
CAM_ExpCompPosInq	8x 09 04 4E FF	y0 50 00 00 0p 0q FF	pq : ExpComp Position
CAM_FlickerlessInq	8x 09 04 7A FF	y0 50 02 FF	On
		y0 50 03 FF	Off
CAM_BLCModelnq	8x 09 04 33 FF	y0 50 02 FF	On
		y0 50 03 FF	Off
CAM_BLCAreaInq	8x 09 04 3C 00 FF	y0 50 0p FF	p : BLC Mode - 0(AREA OSD Off), 1(AREA OSD On)
CAM_BLC_StartXInq	8x 09 04 3C 10 FF	y0 50 00 00 0p 0q FF	pq : Start Horizontal Position (0 ~ 36h)
CAM_BLC_StartYInq	8x 09 04 3C 20 FF	y0 50 00 00 0p 0q FF	pq : Start Vertical Position (0 ~ 3Ch)
CAM_BLC_EndXInq	8x 09 04 3C 30 FF	y0 50 00 00 0p 0q FF	pq : End Horizontal Position (4~3Ah)
CAM_BLC_EndYInq	8x 09 04 3C 40 FF	y0 50 00 00 0p 0q FF	pq : End Vertical Position (4~40h)

Command List

< Inquiry Command >

Inquiry Command	Command Packet	Inquiry Packet	Comments
CAM_HLCModelInq	8x 09 04 32 00 FF	y0 50 0p FF	p : HLC Mode - 0(Off), 1(On), 2(Night)
CAM_HLCLevelInq	8x 09 04 32 10 FF	y0 50 00 00 0p 0q FF	pq : HLC Level (0 ~ 14h)
CAM_HLCColorInq	8x 09 04 32 30 FF	y0 50 0p FF	p : HLC Color - 0 ~ Dh (0:BLK, 1~6:Gray1~6, 7:WHT, 8:RED, 9:GRN, Ah:BLU, Bh:CYN, Ch:YEL, Dh:MAG)
CAM_WDModelInq	8x 09 04 3D FF	y0 50 02 FF	On
		y0 50 03 FF	Off
CAM_WDLevelInq	8x 09 04 7D FF	y0 50 0p FF	p : WDR Level (0 ~ 4)
CAM_ACEInq	8x 01 04 1A FF	y0 50 02 FF	On
		y0 50 03 FF	Off
CAM_ACELevelInq	8x 09 04 1A 10 FF	y0 50 0p FF	p : ACE Level (0 ~ 2)
CAM_DefogInq	8x 09 04 65 FF	y0 50 02 FF	On
		y0 50 03 FF	Off
CAM_DefogLevelInq	8x 09 04 65 10 FF	y0 50 0p FF	p : Defog Level (0 ~ 2)
CAM_DefogModelInq	8x 09 04 65 20 FF	y0 50 0p FF	p : Defog Mode - 0(Manual), 1(Auto)
CAM_DNRModelInq	8x 09 04 53 FF	y0 50 0p FF	p : 0 (Off), 1 ~ 3 (Manual Level), 4 (Auto)
CAM_GammaInq	8x 09 04 5B FF	y0 50 0p FF	p: Gamma setting - 0(0.45) ~ 4(0.65)
CAM_ApertureInq	8x 09 04 42 FF	y0 50 00 00 0p 0q FF	pq: Aperture Gain (0 ~ Ah)
CAM_LR_ReverseModelInq	8x 09 04 61 FF	y0 50 02 FF	On
		y0 50 03 FF	Off
CAM_FreezeModelInq	8x 09 04 62 FF	y0 50 02 FF	On
		y0 50 03 FF	Off
CAM_PictureFlipModelInq	8x 09 04 66 FF	y0 50 02 FF	On
		y0 50 03 FF	Off
CAM_ICRStateInq	8x 09 04 01 FF	y0 50 02 FF	Night
		y0 50 03 FF	Day
CAM_ICRModelInq	8x 09 04 51 FF	y0 50 02 FF	Night
		y0 50 03 FF	Day
		y0 50 04 FF	ICR is changed automaticaly by AGC Gain
		y0 50 06 FF	ICR is changed by external input
CAM_ICRThresholdInq	8x 09 04 21 FF	y0 50 00 00 0p 0q FF	pq : Trheshold level of Auto Mode (0 ~ 1Ch)
CAM_ICRGapInq	8x 09 04 21 10 FF	y0 50 0p FF	p : On/Off Threshold Gap of Auto mode(0 ~ 4)
CAM_AutoICRDelayInq	8x 09 04 41 FF	y0 50 00 00 0p 0q FF	pq : Auto mode delay - 0(0sec)~FFh(255sec)
CAM_Ext-InICRDelayInq	8x 09 04 71 FF	y0 50 00 00 0p 0q FF	pq : Ext-In mode delay - 0(0sec)~FFh(255sec)
CAM_BurstInq	8x 09 04 72 FF	y0 50 02 FF	On
		y0 50 03 FF	Off
CAM_MemoryInq	8x 09 04 3F FF	y0 50 0p FF	p: Last Recall Memory No.
CAM_MemSaveInq	8x 09 04 23 0t FF	y0 50 0p 0q 0r 0s FF	t : 0 ~ 7 (Address) pqrs : 0000 ~ FFFFh (Data)

Command List

< Inquiry Command >

Inquiry Command	Command Packet	Inquiry Packet	Comments
CAM_DisplayInq	8x 09 04 15 FF	y0 50 02 FF	On
		y0 50 03 FF	Off
CAM_DispSellInq	8x 09 04 14 00 FF	y0 50 0p FF	Display Item On(1)/Off(0) p : bit[0] - ID, bit[1] - Title, bit[2] - Zoom Position, bit[3] - System Message
CAM_TitleDisplayModelInq	8x 09 04 74 FF	y0 50 02 FF	On
		y0 50 03 FF	Off
CAM_MenuModelInq	8x 09 04 16 FF	y0 50 02 FF	OSD menu On
		y0 50 03 FF	OSD menu Off
CAM_BlueScreenModelInq	8x 09 05 20 FF	y0 50 0p FF	p : Blue Screen Display - 0(Off), 1(On)
CAM_MuteModelInq	8x 09 04 75 FF	y0 50 02 FF	On
		y0 50 03 FF	Off
CAM_PrivacyPosInq	8x 09 04 76 mm FF	y0 50 0n 0p 0p 0r 0r 0s 0s FF	mm : Mask Number n : 0(Non-interlock Mode), 1(Interlock Mode) pp : X, qq : Y, rr : W, ss : H
CAM_PrivacyDisplayInq	8x 09 04 77 FF	y0 50 pp pp pp pp FF	pppppppp : Mask Display (0: OFF, 1: ON)
CAM_PrivacyColorInq	8x 09 04 78 FF	y0 50 pp pp pp pp qq rr FF	pppppppp : Mask Color Setting qq : Color Setting when 0 is selected Rr : Color Setting when 1 is selected
CAM_PrivacyMonitorInq	8x 09 04 6F FF	y0 50 pp pp pp pp FF	pppppppp : Mask is displayed now
CAM_KeyLockInq	8x 09 04 17 FF	y0 50 02 FF	On
		y0 50 00 FF	Off
CAM_IDInq	8x 09 04 22 FF	y0 50 0p 0q 0r 0s FF	pqrs: Camera ID
CAM_VersionInq	8x 09 00 02 FF	y0 50 00 20 mn pq rs tu vw FF	mnpq : Model Code (0466h) rstu : ROM version (0100h) vw : Socket Number (3)
CAM_ModelInq	8x 09 00 37 FF	y0 50 pp pp pp qq qq FF	pppppp : Model Code *MM-11-A : YY4938h *MM-12-A : YY4838h (YY : Custom. Code, standard model = 00) qqqq : Version
CAM_MDModelInq	8x 09 04 1B FF	y0 50 02 FF	On
		y0 50 03 FF	Off
CAM_MDFunctionInq	8x 09 04 1C FF	y0 50 0m 0n 0p 0q 0r 0s FF	m : Display mode n : Detection Frame Set (bit[0]:1, bit[1]:2, bit[3]:3) pq : Threshold Level (00 ~ 14h) rs : Interval Time set (00 ~ FFh)
CAM_MDWindowInq	8x 09 04 1D 0m FF	y0 50 0p 0q 0r 0s FF	m : Select Detection Frame Number (0,1,2) p : Start Horizontal Position (00 ~ 0Eh) q : Start Vertical Position (00 ~ 07) r : Stop Horizontal Position (01 ~ 0Fh) s : Stop Vertical Position (01 ~ 08h)

CONFIDENTIAL

2.1Mpixels Module
MM-13

Edition : v1.01

Issued Date: 29. Oct. 13

Command List

< Inquiry Command >

Inquiry Command	Command Packet	Inquiry Packet	Comments
CAM_RegisterValueInq	8x 09 04 24 mm FF	y0 50 0p 0p FF	mm : Register No. (00, 52h, 60h, 72h, 73h, 7Ah) pp : Register Value

Command List

< Exposure control values >

Shutter Speed (Hex)

Step (Hex)	NTSC		PAL	
	30fps	60fps	30fps	60fps
0E	1/30000	1/60000	1/30000	1/60000
0D	1/10000	1/30000	1/10000	1/30000
0C	1/7000	1/10000	1/7000	1/10000
0B	1/5000	1/7000	1/5000	1/7000
0A	1/2500	1/5000	1/2500	1/5000
09	1/1600	1/2500	1/1600	1/2500
08	1/1000	1/1600	1/1000	1/1600
07	1/700	1/1000	1/700	1/1000
06	1/250	1/700	1/250	1/700
05	1/120	1/250	1/100	1/250
04	1/60	1/120	1/50	1/100
03	1/30	1/60	1/25	1/50
02	X2 (1/15)	X2 (1/30)	X2 (1/12)	X2 (1/25)
01	X3 (1/10)	X3 (1/15)	X3 (1/8)	X3 (1/12)
00	X4 (1/7)	X4 (1/10)	X4 (1/6)	X4 (1/8)

< D-Zoom control values >

D-Zoom : Separate Mode

Magnification	Zoom Position
x1	00
x2	80
x3	AA
x4	C0
x5	CC
x6	D5
x7	DB
x8	E0
x9	E3
x10	E6
x11	E8
x12	EB
x13	ED
x14	EE
x15	EF
x16	F0
x17	F1
x18	F2
x19	F3
x21	F4
x23	F5
x25	F6
x28	F7
x32	F8

Command List

< OSD character values >

V position	00 ~ 0Dh	14 Rows
H position	00 ~ 27h	40 Columns

Character code

Code	Character	Code	Character	Code	Character	Code	Character
00	Space	21	A	42	b	63	Ç
01	!	22	B	43	c	64	È
02	"	23	C	44	d	65	É
03	#	24	D	45	e	66	Ê
04	\$	25	E	46	f	67	Ë
05	%	26	F	47	g	68	Ï
06	&	27	G	48	h	69	Ī
07		28	H	49	i	6A	Ñ
08	(29	I	4A	j	6B	Ô
09)	2A	J	4B	k	6C	Ö
0A	*	2B	K	4C	l	6D	Ù
0B	+	2C	L	4D	m	6E	Ú
0C	,	2D	M	4E	n	6F	Û
0D	-	2E	N	4F	o	70	ß
0E	.	2F	O	50	p	71	à
0F	/	30	P	51	q	72	á
10	0	31	Q	52	r	73	ä
11	1	32	R	53	s	74	ç
12	2	33	S	54	t	75	è
13	3	34	T	55	u	76	é
14	4	35	U	56	v	77	ê
15	5	36	V	57	w	78	ë
16	6	37	W	58	x	79	ï
17	7	38	X	59	y	7A	ī
18	8	39	Y	5A	z	7B	ñ
19	9	3A	Z	5B	{	7C	ô
1A	:	3B	[5C		7D	ö
1B	;	3C	\	5D	}	7E	ù
1C	<	3D]	5E	~	7F	û
1D	=	3E	^	5F		80	ü
1E	>	3F	_	60	À	81	Œ
1F	?	40	`	61	Â	82	œ
20	@	41	a	62	Ä		

Command List

< Other control values >

R Gain	00	~	14h
B Gain	00	~	14h
Aperture Level	00	~	0Ah
Threshold Level of ICR	00	~	1Ch
Gap Level of ICR	00	~	02h

Register Setting

Function	Register No.	Value	
BaudRate	00	10	2400 bps
		11	4800 bps
		00	9600 bps
		01	19200 bps
		02	38400 bps
		03	57600 bps
		04	115200 bps
E.ZOOM Max	52	00 ~ F8	Max. DZoom Ratio = 256 / (256 - Value)
Language	60	00	English
		01	Japanese
		03	Simplified Chinese
		05	Traditional Chinese
Monitoring Mode	72	06	1080p/30fps
		08	1080p/25fps
		09	720p/60fps
		0C	720p/50fps
		01	1080i/60fps
		04	1080i/50fps
		13	1080p/60fps
		14	1080p/50fps
Output Enabling	73	02	Analog Output disabled
		03	Analog Output enabled
VD / HD Polarity	7A	00	Positive
		01	Negative

OSD Menu**III. OSD****◆ Main Menu**

MENU	
MODEL	D&N
EXPOSURE	↓
WHITE BAL	↓
IMAGE	↓
INTELLIGENCE	↓
SPECIAL FUNC	↓
DISPLAY	↓
[EXIT]	[SAVE] [DFLT]

Functions can be setup using "Menu Key Command" of Visca protocol.
The menu consists of the "Main Menu" and "Sub Menu".
The main menu is displayed where 7 camera functions can be selected.
To the push of each main menu selection, the sub-menu is displayed

If you want save the menu, select [SAVE].

If you want not save the menu, select [EXIT] (After select , Power off -> on)

If you want default the menu, select [DFLT]

◆ MODEL**◆ MODEL : Select model**

- ▶ D&N / IR CDS

OSD Menu

◆ **EXPOSURE**

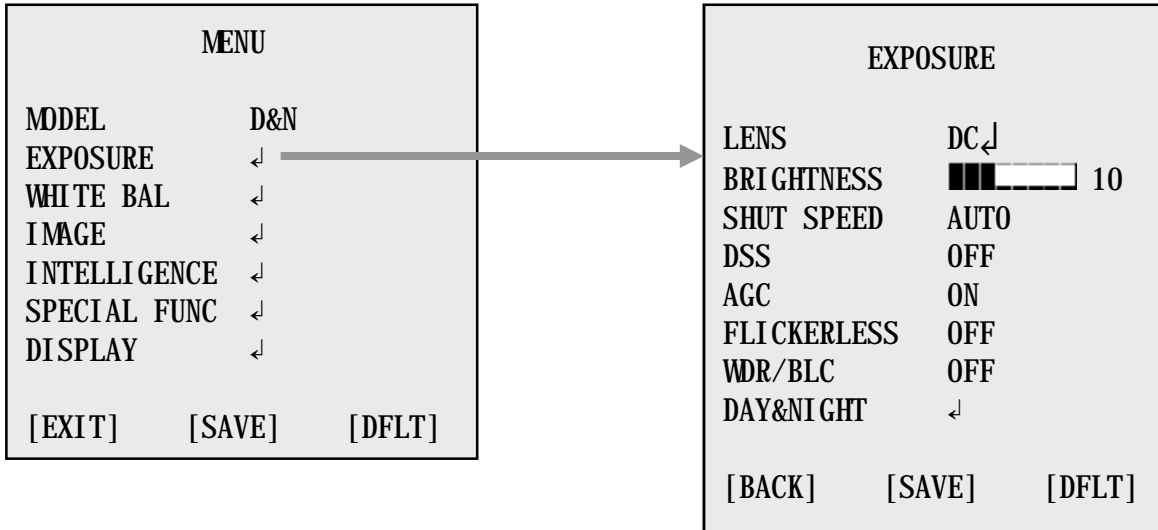

◆ **LENS : Select LENS type**

- ▶ DC
 - ▷ MODE : INDOOR, OUTDOOR, DEBLUR
- ▶ MANUAL
 - ▷ MODE : NORMAL, DEBLUR

◆ **BRIGHTNESS : Adjust brightness level**

- ▶ 0(dark) ~ 20(bright) steps

◆ **SHUT SPEED : Can be set in AUTO or MANUAL**

- ▶ AUTO / x4, x3, x2, 1/30(25)*, 1/60(50), 1/120(100), 1/250, 1/700, 1/1000, 1/1600, 1/2500, 1/5000, 1/7000, 1/10000, 1/30000, 1/60000 sec

*) It is only valid when HD format is 1080p_30(25).

◆ **DSS : Select maximum DSS(Digital Slow Shutter)**

- ▶ OFF / x2, x3, x4

◆ **FLICKERLESS : Select Flickerless mode**

- ▶ OFF / ON (remove screen flicker)

◆ **AGC : Select Auto Gain Control**

- ▶ OFF / ON

**OSD Menu**

- ◆ **WDR/BLC** : Select WDR(Wide Dynamic Range) or BLC(Back Light compensation)
 - ▶ **WDR**↓
 - ▷ **LEVEL** : Adjust WDR level.
 - ▶ **LOW, MID- LOW, MIDDLE, MID- HIGH, HIGH**
 - ※ **WDR** doesn't work in Shutter Manual Mode and CVBS enable mode.
 - ▶ **BLC**↓
 - ▷ **POSITION** : Adjust the window position
 - ▷ **SIZE** : Adjust the window size
 - ※ **Can't use WDR and BLC at the same time.**
(When WDR On, BLC is Off. And when BLC is On, WDR is Off)

- ◆ **DAY&NIGHT** : Select Day&Night
 - ▷ **MODE** : AUTO / EXT- IN / DAY / NIGHT
 - ▶ **AUTO**↓ (When using IR- CDS model)
 - ▷ **POLARITY** : ACTIVE LOW / HIGH
 - ▶ **EXT- IN**↓ (When using D&N and COLOR model)
 - ▷ **POLARITY** : ACTIVE LOW / HIGH
 - ▷ **DELAY** : 0 ~ 255 sec
 - ▷ **THRS** : 0 ~ 28
 - Day↔Night switching level in Auto Mode.
 - Switching in lower lux with higher threshold level.
 - ▷ **GAP** : LOW, MID- LOW, MIDDLE, MID- HIGH, HIGH
 - Margin between Day →Night switching level and Night →Day switching level.
 - ▷ **ANTI- SAT** : LED saturation improves. (0~20)
 - ▷ **BURST** : OFF / ON

OSD Menu

◆ **WHITE BALANCE**

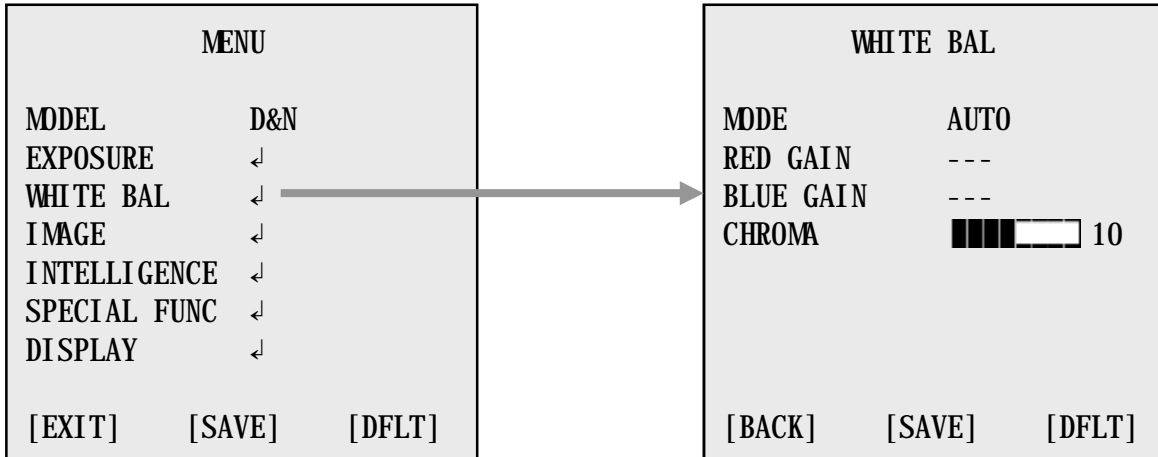

◆ **AWB : Select WHITE BALANCE mode**

▶ **AUTO / ONE PUSH / MANUAL / INDOOR / OUTDOOR**

- ▷ **AUTO** : Automatically adjusts color according to the available lighting.
- ▷ **ONE PUSH** : It is a fixed white balance mode that may be automatically readjusted only by pressing ONE PUSH
- ▷ **MANUAL**↓ : Color can be corrected when the user increases or decreases "RED GAIN" or "BLUE GAIN".
- ▷ **INDOOR** : Set color temperature to be Indoor light (3700°K)
- ▷ **OUTDOOR** : Set color temperature to be Outdoor light (5100°K)

◆ **RED GAIN : Adjust R gain value**

- ▶ **0 ~ 20 steps**

◆ **BLUE GAIN : Adjust B gain value**

- ▶ **0 ~ 20 steps**

◆ **CHROMA : Adjust CHROMA gain value**

- ▶ **0 ~ 20 steps**

OSD Menu

◆ **IMAGE**

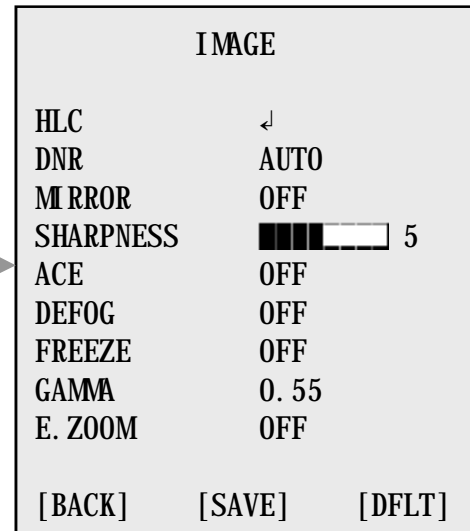
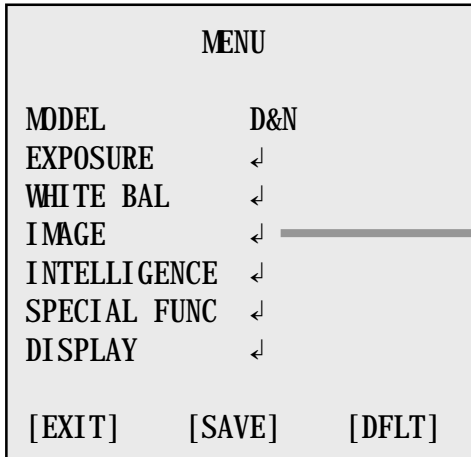

◆ **HLC : Select High Light Compensation.**

When extremely bright light is projected to the camera masking is used on the portion to prevent partial saturation on the monitor.

- ▷ **MODE : OFF / ON / NIGHT**
- ▷ **LEVEL : 0 ~ 20 steps**
- ▷ **COLOR : 0 ~ 13 steps**

◆ **DNR : Select Digital Noise Reduction**

- ▶ **AUTO / OFF / LOW / MIDDLE / HIGH**

◆ **MIRROR : Select a flip mode**

- ▶ **OFF / H / V / H&V**
 - ▷ **H : You can flip the picture horizontally on the screen**
 - ▷ **V : You can flip the picture vertically on the screen**
 - ▷ **H&V : You can flip the picture horizontally & vertically on the screen**

◆ **SHARPNESS : Adjust sharpness level**

- ▶ **0 ~ 10 steps**

◆ **ACE : Select Digital WDR (Wide Dynamic Range)**

- ▶ **OFF / LOW / MIDDLE / HIGH**

◆ **DEFOG : Carry out defog function**

- ▶ **OFF / ON↓**
 - ▷ **MODE : AUTO / MANUAL**
 - ▷ **LEVEL : LOW / MIDDLE / HIGH**

※ **Can't use DEFOG and ACE at the same time**

(When ACE On, DEFOG is Off. And when DEFOG is On, ACE is Off)

**OSD Menu**

- ◆ **Freeze : Select real or still mode**
 - ▶ **OFF / ON**
- ◆ **GAMMA : Select GAMMA**
 - ▶ **0.45 / 0.50 / 0.55 / 0.60 / 0.65**
- ◆ **E.ZOOM**
 - ▶ **OFF / ON**
 - ▷ **LIMIT : Max x2 ~ x19, x21, x23, x25, x28, x32**
 - ▷ **POSITION : Select maximum digital zoom magnification.**
 - ※ **Can't use Digital Zoom when the motion detection is turned on.**

OSD Menu

◆ **INTELLIGENCE**

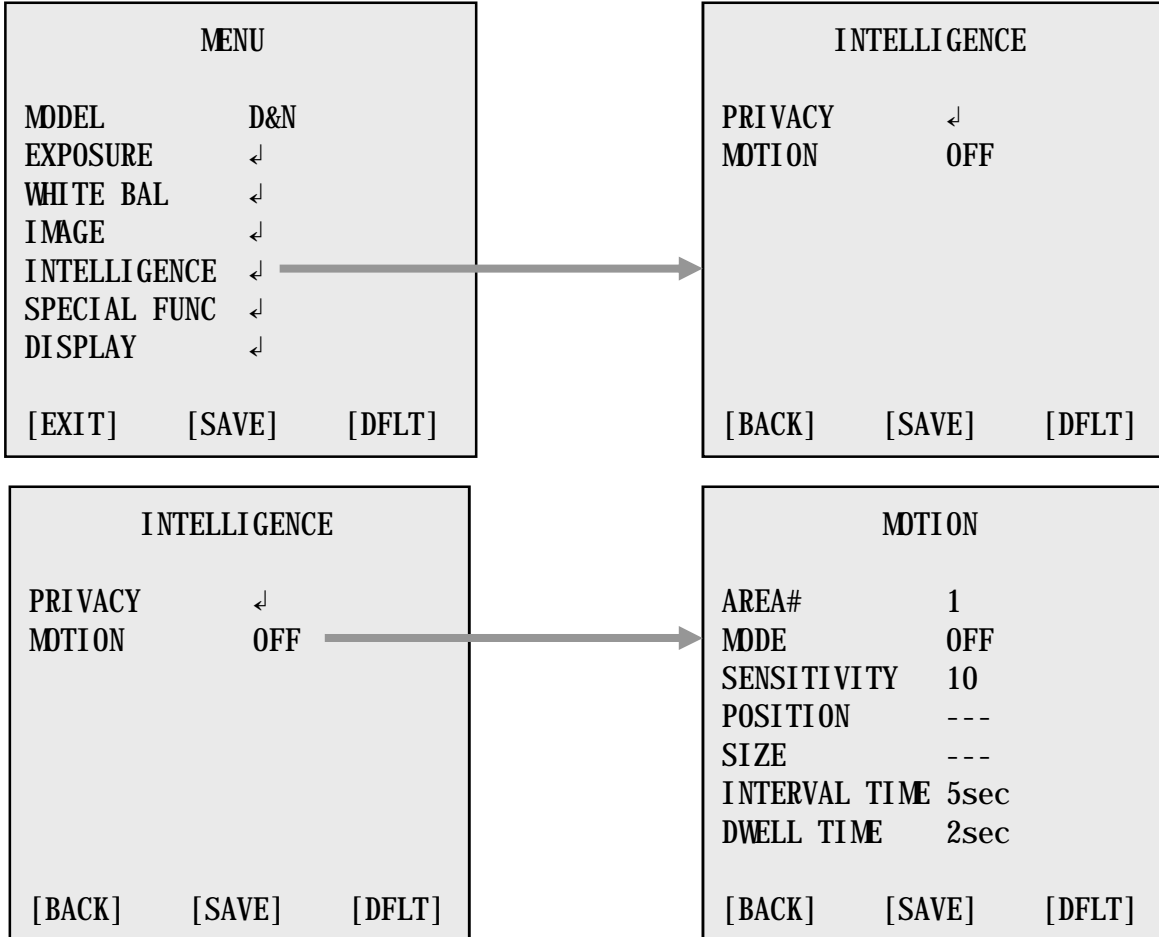

◆ **MOTION** : When there is movement of the subject in the screen, there will be an motion detection

▶ **OFF / ON** ↓

- ▷ **AREA#** : Setting 3 areas(1~3) of motion detection
- ▷ **MODE** : OFF / ON (Limit and define areas of motion detection)
- ▷ **SENSITIVITY** : Adjust sensitivity of MD (0 ~ 20 steps)
More sensitive to setting to low step with sensitivity
- ▷ **POSITION** : Adjust the Area position
- ▷ **SIZE** : Adjust the Area size
- ▷ **INTERVAL TIME** :Select the alarm interval time (0 ~ 255sec)
- ▷ **DWELL TIME** : Select the duration time about changing MD mode (0 ~ 255sec)

OSD Menu

◆ **PRIVACY**

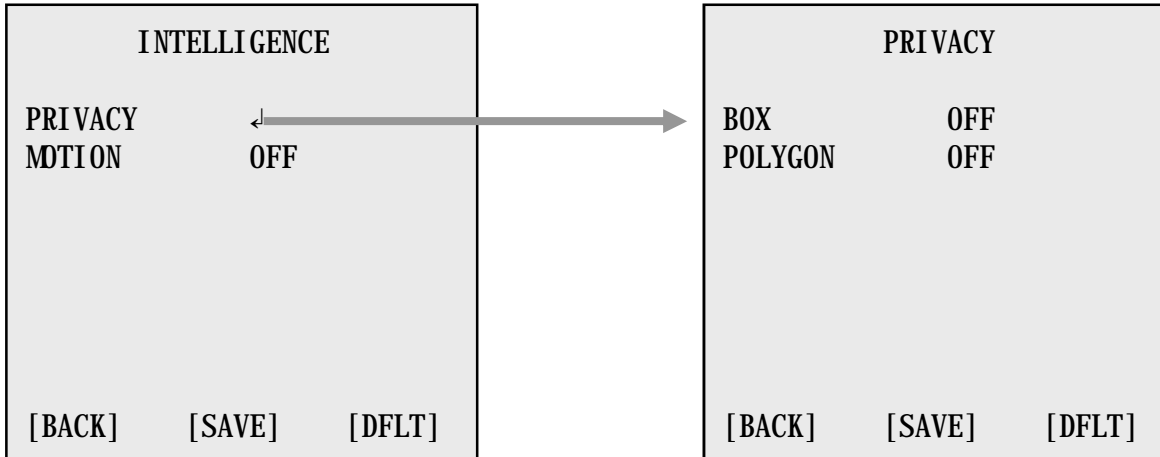

◆ **BOX: Hide an rectangle area you want to hide on the screen**

- ▶ **OFF / ON**↓
 - ▷ **MASK#** : Select mask area number (1 ~ 24)
 - ▷ **MODE** : Mask enable or disable (OFF / ON)
 - ▷ **POSITION** : Adjust the mask position
 - ▷ **SIZE** : Adjust the mask size
 - ▷ **COLOR** : Select mask color (0 ~ 13)
 - ▷ **TRANS** : Select mask transparency level (0 ~ 3)

◆ **POLYGON : Hide an polygonal area you want to hide on the screen**

- ▶ **OFF / ON**↓
 - ▷ **MASK#** : Select mask area number (1 ~ 8)
 - ▷ **MODE** : Mask enable or disable (OFF / ON)
 - ▷ **POS0** : Adjust the mask position 0
 - ▷ **POS1** : Adjust the mask position 1
 - ▷ **POS2** : Adjust the mask position 2
 - ▷ **POS3** : Adjust the mask position 3
 - ▷ **COLOR** : Select mask color (0 ~ 13)
 - ▷ **TRANS** : Select mask transparency level (0 ~ 3)

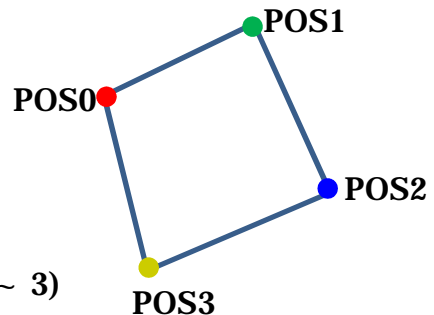

OSD Menu

◆ **SPECIAL FUNC**

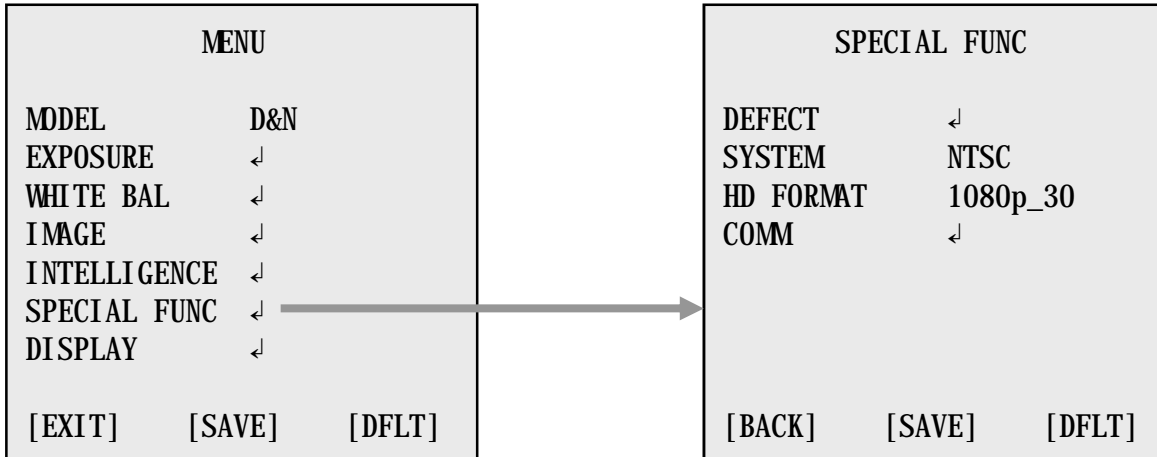

- ◆ **DEFECT** : Compensates for bad pixels that may occur. Occurs when the whole screen is in full black or if there is bad pixelation and it changes the THRS values until the screen is fixed.
- ◆ **SYSTEM** : Select NTSC(30/60fps) or PAL(25/50fps).
- ◆ **HD FORMAT** : Select Digital output
1080p_30(25), 720p_60(50), 1080i_60(50), 1080p60(50)
- ◆ **COMM** : Set up the camera ID, baud rate, protocol
 - ▷ **ID** : Select the camera ID
 - ▶ 1 ~ 255
 - ▷ **BAUD RATE** : Select serial communication speed
 - ▶ 2400 / 4800 / 9600 / 19200 / 38400 / 57600 / 115200bps
 - ▷ **PROTOCOL** : Select operating protocol
 - ▶ VISCA / PELCO- D / PELCO- P / UPDATE

OSD Menu

◆ **DISPLAY**

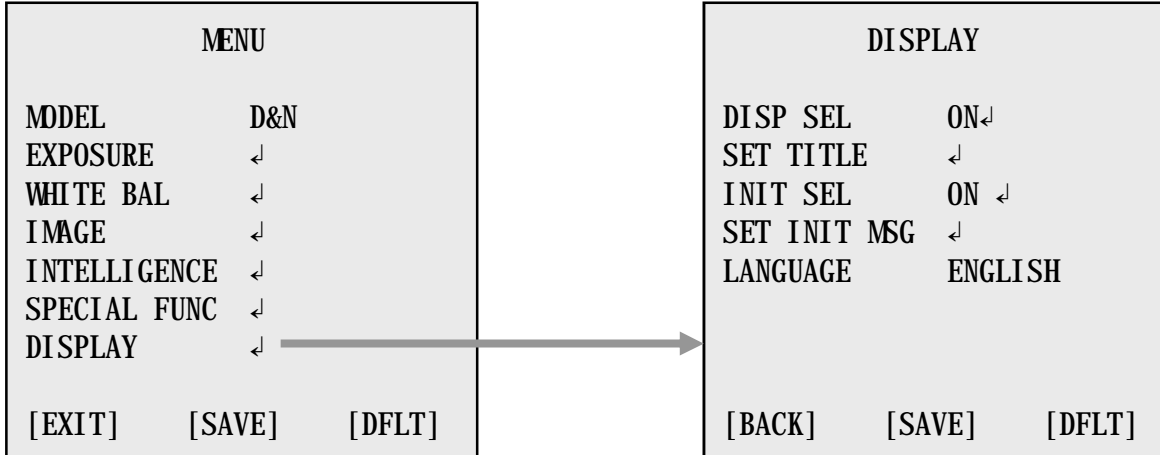

◆ **DISP SEL : Select display item.**

- ▶ **OFF / ON↓**
 - ▷ **ID : OFF / ON**
 - ▷ **TITLE : OFF / ON**
 - ▷ **ZOOM RATIO : OFF / ON**
 - ▷ **SYSTEM MSG : OFF / ON (MD Alarm and Wait message)**

◆ **SET TITLE : Select camera title menu (Text edit- max 40 characters)**

◆ **INIT SEL : Select display initial message.**

- ▶ **OFF / ON↓**
 - ▷ **ID : OFF / ON**
 - ▷ **BAUDRATE : OFF / ON**
 - ▷ **PROTOCOL : OFF / ON**
 - ▷ **VERSION : OFF / ON**
 - ▷ **INIT MSG : OFF / ON**

◆ **SET INIT MSG : modify initial message. (Text edit – max 40 characters)**

◆ **LANGUAGE : Select language.**

- ▶ **English / Simplified Chinese / Traditional Chinese / Japanese**

※ **Character Table of Text edit Mode**

A B C D E F G H I J K L M N O P Q R S T
 U V W X Y Z a b c d e f g h i j k l m n
 o p q r s t u v w x y z , . () { } []
 0 1 2 3 4 5 6 7 8 9 * + - / = ~ ! ? "

CONFIDENTIAL

2.1Mpixels Module
MM-13

Edition : v1.01
Issued Date: 29. Oct. 13

Drawing 

T=1.6

